

METRIC

MIL-STD-1275D

29 August 2006

SUPERSEDING

MIL-STD-1275C

23 June 2006

**DEPARTMENT OF DEFENSE
INTERFACE STANDARD**

**CHARACTERISTICS OF
28 VOLT DC
ELECTRICAL SYSTEMS IN
MILITARY VEHICLES**



MIL-STD-1275D

FOREWORD

1. This standard is approved for use by all departments and agencies of the Department of Defense (DOD).
2. The intent of this document is to provide standard limiting voltage characteristics for 28-volt direct current electric circuits on military ground platforms and electrical devices under test.
3. The authority shall designate responsibility for establishing appropriate characteristics of components powered from sources other than 28 VDC within the vehicle system.
4. Comments, suggestions, or questions on this document should be addressed to Tank-automotive and Armaments Command, 6501 E. 11 Mile Road, Warren, MI 48397-5000 or emailed to standardization@tacom.army.mil. Since contact information can change, you may want to verify the currency of this address information using the ASSIST online database at <http://assist.daps.dla.mil>.

MIL-STD-1275D

CONTENTS

<u>PARAGRAPH</u>		<u>PAGE</u>
	<u>FOREWORD</u>	ii
1.	<u>SCOPE</u>	1
1.1	Scope.....	1
2.	<u>APPLICABLE DOCUMENTS</u>	1
2.1	General	1
2.2	Government documents	1
2.2.1	Specifications, standards, and handbooks	1
2.3	Non-Government Documents.....	1
2.3.1	Specifications, standards, and handbooks	1
2.4	Order of precedence.....	2
3.	<u>DEFINITIONS</u>	2
3.1	General	2
3.1.1	Vehicle power supply system	2
3.1.2	Transients.....	2
3.1.2.1	Surge.....	2
3.1.2.2	Spike.....	3
3.1.3	Steady-state.....	3
3.1.4	Recovery time	4
3.1.5	Ripple	4
3.1.6	Starting disturbances	5
3.1.7	Electrical Device Under Test (EDUT).....	5
3.1.8	Rise Time.....	5
3.1.9	Fall Time.....	5
4.	<u>GENERAL REQUIREMENTS</u>	6
4.1	Temperature conditions	6
4.2	Circuit characteristics point of measurement.....	6
4.3	EDUT compatibility	6
4.4	Polarity	6
4.5	Load banks.....	6
4.6	Battery condition.....	6

MIL-STD-1275D

5.	<u>DETAILED REQUIREMENTS</u>	6
5.1	Military ground platform electrical system requirements.	6
5.1.1	Electromagnetic compatibility.....	6
5.1.2	Starting mode.....	7
5.1.2.1	Starting disturbances.....	7
5.1.2.2	Initial engagement surges.....	7
5.1.2.3	Cranking level.....	7
5.1.3	Normal operating mode.....	7
5.1.3.1	Steady-state voltage.....	7
5.1.3.2	Ripple.....	7
5.1.3.3	Surges.....	8
5.1.3.4	Spikes.....	9
5.1.4	Generator-only mode.....	9
5.1.4.1	Steady-state voltage.....	9
5.1.4.2	Ripple.....	9
5.1.4.3	Surges.....	10
5.1.4.4	Spikes.....	11
5.2	Compatibility of power supply system and utilization equipment.....	11
5.3	Test methods	11
5.3.1	Vehicle electrical system.	12
5.3.2	Vehicle equipment.....	12
5.3.2.1	General.	12
5.3.2.2	Voltage spikes exported from EDUT.....	13
5.3.2.3	Voltage spikes imported into EDUT.....	15
5.3.2.4	Voltage surges imported into EDUT.....	16
5.3.2.5	Ripple voltage imported into EDUT.....	16
6.	<u>NOTES</u>	17
6.1	Intended Use.....	17
6.2	Subject term (key word) listing.....	17
6.3	International interest.....	17
6.4	Changes from previous issue.....	17

MIL-STD-1275D

<u>FIGURES</u>		<u>PAGE</u>
1.	Illustrative Spike.....	3
2.	Illustrative Surge with Recovery Time	4
3.	General View of Ripple.	4
4.	Starting Disturbances	5
5.	Envelope of Surges in Normal Operating Mode for 28 VDC Systems.....	8
6.	Envelope of Spikes in Normal Operating Mode for 28 VDC Systems.....	9
7.	Envelope of Surges in Generator-only Mode for 28 VDC Systems.....	10
8.	Envelope of Spikes in Generator-only Mode for 28 VDC Systems.....	11
9.	Exported Spike Test Circuit.....	13
10.	Exported Spike Test Circuit (EDUT With Remote Switch).....	14
11.	Imported Spike Test Circuit.....	14
12.	Imported Surge Test Circuit for 28 VDC System.....	15

MIL-STD-1275D

1. SCOPE

1.1 Scope. This standard covers the limits of steady state and transient voltage characteristics 28 VDC electrical power systems for military ground vehicles.

2. APPLICABLE DOCUMENTS

2.1 General. The documents listed in this section are specified in sections 3, 4 and 5 of this standard. This section does not include documents cited in other sections of this standard or recommended for additional information or as examples. While every effort has been made to ensure the completeness of this list, document users are cautioned that they must meet all specified requirement documents cited in sections 3, 4 and 5 of this standard, whether or not they are listed.

2.2 Government documents.

2.2.1 Specifications, standards, and handbooks. The following specifications, standards, and handbooks form a part of this document to the extent specified herein. Unless otherwise specified, the issues of these documents are those listed in the issue of the Department of Defense Index of Specifications and Standards (DoDISS) and supplement thereto, cited in the solicitation.

Department of Defense

MIL-STD-461	Requirements for the Control of Electromagnetic Interference Characteristics of Subsystems and Equipment
-------------	--

(Copies of the above documents are available online at <http://assist.daps.dla.mil/quicksearch/> or www.dodssp.daps.mil/ or from the Standardization Document Order Desk, 700 Robbins Avenue, Building 4D, Philadelphia, PA 19111-5094).

2.3 Non-Government Documents. The following documents form a part of this document to the extent specified herein. Unless otherwise specified, the issues of documents are those cited in the solicitation or contract.

2.3.1 Specifications, standards, and handbooks.

MIL-STD-1275D

Society of Automotive Engineers (SAE)

SAE J1113-2	Immunity to Conducted, 30 Hz to 250 kHz, Power Leads
SAE J1113-11	Immunity to Conducted Transients on Power Leads
SAE J1113-13	Electromagnetic Compatibility Measurements Procedure for Vehicle Components – Part 13: Immunity to Electrostatic Discharge
SAE J1113-42	Conducted Transient Emissions

(Copies of the above documents are available from www.sae.org or from Society of Automotive Engineers, Inc. 400 Commonwealth Drive, Warrendale, PA 15096-0001).

2.4 Order of precedence. In the event of a conflict between the text of this document and the references cited herein, the text of this document takes precedence. Nothing in this document, however, supersedes applicable laws and regulations unless a specific exemption has been obtained.

3. DEFINITIONS

3.1 General. For the purposes of this standard, the following definitions may apply.

3.1.1 Vehicle power supply system. The DC voltage and current generating equipment, storage batteries, and distribution equipment normally fitted to the vehicle comprise the power supply system. Power is supplied from this system to the utilization equipment or electrical device under test.

3.1.2 Transients. Transients are the changing conditions of a characteristic. These usually go beyond the steady-state limits, return to and remain within the steady-state limits within a specified time. The transient may take the form of either a surge or a spike. The elements of transient waveform characteristics are identified in paragraph A.2 and Figure A1 of SAE J1113-42.

3.1.2.1 Surge. A surge is a variation from the controlled steady-state level of a characteristic, resulting from the inherent regulation of the electric power supply system and remedial action by the regulator, except for battery only operation. Surges may also occur due to the application of loads in the battery only condition. Surges are transients with duration greater than 1 ms and have a recovery time limitation.

MIL-STD-1275D

3.1.2.2 Spike. A spike is a high frequency oscillatory variation from the controlled steady-state level of a characteristic. It results from very high frequency currents of complex waveforms produced when reactive loads are switched. An example of a spike waveform is shown in Figure 1. An individual spike generally has an interval lasting less than 50 microseconds (μs) but may take up to one millisecond (ms) to decay to the steady-state level.

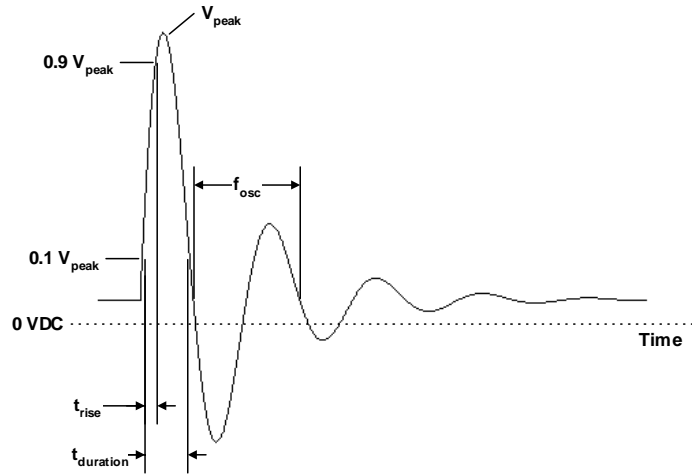

FIGURE 1. Illustrative Spike.

3.1.3 Steady-state. The condition in which circuit values remain essentially constant, occurring after all initial transients or fluctuating conditions have subsided. It is also definitive of the condition where, during normal system operation, only inherent or natural changes occur; (i.e., no malfunctions occur and no unanticipated changes are made to any part of the system).

MIL-STD-1275D

3.1.4 Recovery time. The interval between the time a characteristic deviates from the steady-state limits and the time it returns and remains within the same range (see Figure 2).

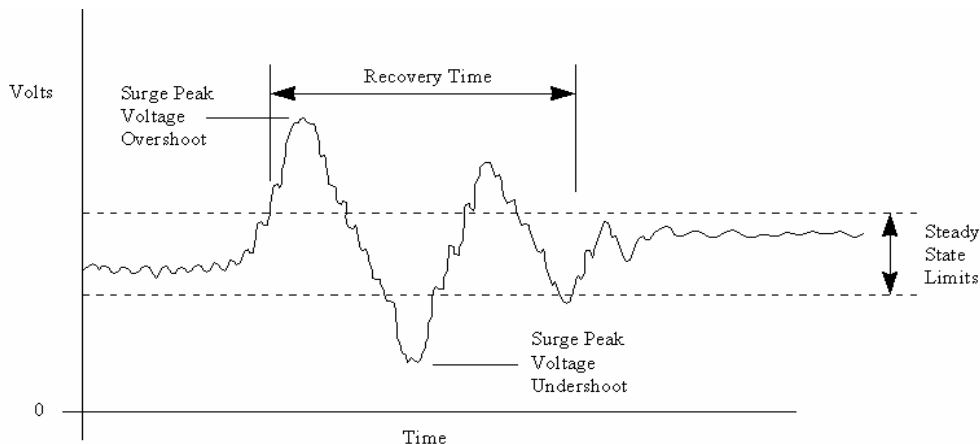

FIGURE 2. Illustrative Surge with Recovery Time.

3.1.5 Ripple. The regular and/or irregular variations of voltage about a fixed DC voltage level during steady-state operation of a DC system. The upper and lower limits of the oscillations are called “Upper Peak of Ripple Voltage” and “Lower Peak of Ripple Voltage,” respectively (see Figure 3).

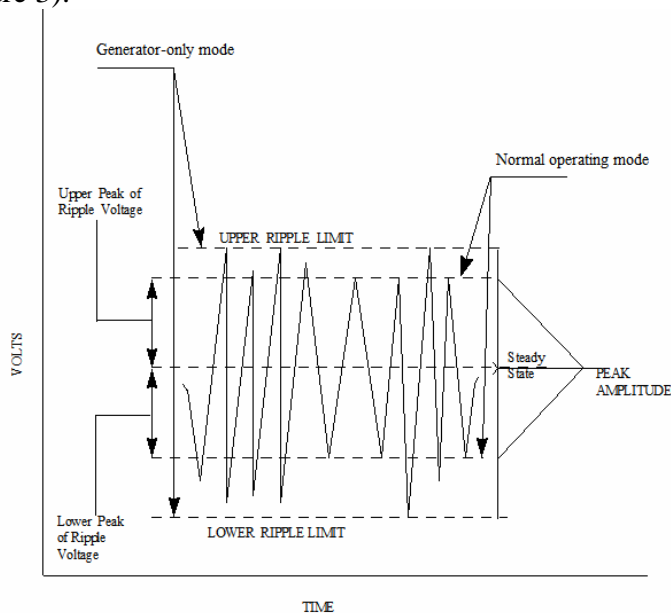

FIGURE 3. General View of Ripple.

MIL-STD-1275D

3.1.6 Starting disturbances. These are undervoltage variations from the steady-state level and are caused by engine starter engagement and cranking. A typical profile showing “Initial Engagement Surge” (IES) and “Cranking Level” is given in Figure 4. The duration of the initial engagement surge is measured from the instant at which it departs from the steady-state value to the instant at which it reaches and remains at the cranking level. The cranking level may last no more than 30 seconds in length and there may be a minimum delay of 2 minutes in between cranking sets. During the initial engagement surge, the voltage may not fall below 6 VDC and the duration may not exceed 1 second. The steady voltage during cranking may not fall below 16 VDC (no more than three cranking attempts of 30 seconds each with 2 minute cranking level pauses between attempts).

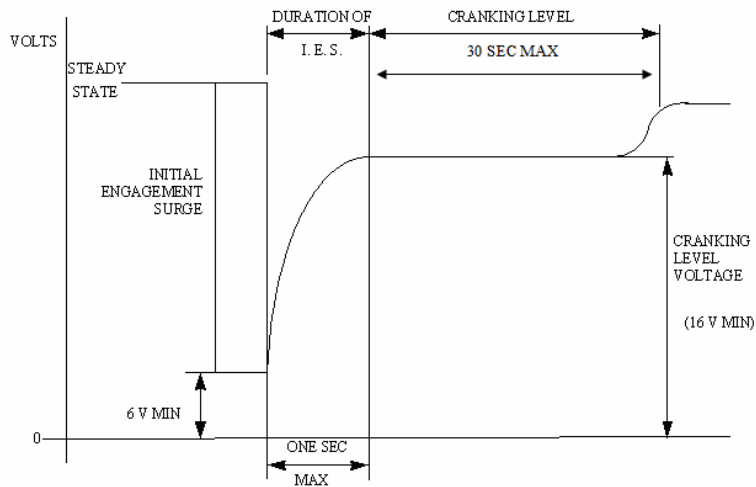

FIGURE 4. Starting Disturbances.

3.1.7 Electrical Device Under Test (EDUT). The electronic device, equipment, or system utilized for testing and evaluation. It is also referred to as utilization equipment.

3.1.8 Rise Time. The rise time is the difference between the time when the signal or voltage transient crosses a low threshold to the time when the signal or voltage transient crosses the high threshold.

3.1.9 Fall Time. The fall time is the difference between the time when the signal or voltage transient crosses a high threshold to the time when the signal or voltage transient crosses the low threshold.

MIL-STD-1275D

4. GENERAL REQUIREMENTS

4.1 Temperature conditions. The limits stated in circuit characteristics shall be determined at the ambient air temperature range of -32°C to $+52^{\circ}\text{C} \pm 2^{\circ}\text{C}$. Additional testing at other temperatures shall be conducted at the discretion of the appropriate authority.

4.2 Circuit characteristics point of measurement. These characteristics apply at the utilization equipment terminals. The starting disturbances, generator surges, and ripple traces shall be recorded at the vehicle battery terminals.

4.3 EDUT compatibility. All EDUT units shall be able withstand voltage transients as specified herein. The EDUT shall continue normal operation without damage to its components. The EDUT shall provide protection against polarity reversal as a result of slave starting or other improper connections.

4.4 Polarity. The negative of the vehicle power supply system shall be grounded to the vehicle metal structure and this ground shall normally be considered the second conductor of the circuit. An additional separate ground cable to the chassis or negative bus bar is recommended for large electrical loads.

4.5 Load banks. Load banks simulating actuating switches, devices, or equipment typically installed on vehicles, can be used in conjunction with the EDUT testing as shown in Figures 9-12.

4.6 Battery condition. All characterizations, with the exception of the generator-only mode, shall be performed with fully charged military vehicle batteries that draw less than 5A from a 28 VDC charging source measured with an electrolyte temperature between 27°C and 38°C .

5. DETAILED REQUIREMENTS

5.1 Military ground platform electrical system requirements.

5.1.1 Electromagnetic compatibility. The vehicle power supply system and utilization equipment shall meet the military ground platform requirements of MIL-STD-461 for conducted emissions (CE), radiated radio frequency (RF) emissions, and susceptibility as applicable for the vehicle and type of EDUT. Vehicle power source systems are exempt from CE102 requirements for their main output power lead(s). For military ground platform requirements, nominal 28 V source voltage limits and ranges in MIL-STD-461 apply equally for 14 VDC components. The packaging, handling, and operation of vehicle electrical components shall also meet requirements for electrostatic discharge (ESD) as established in SAE J1113-13.

MIL-STD-1275D

5.1.2 Starting mode.

5.1.2.1 Starting disturbances. Fully charged military vehicle batteries shall be used, which are batteries that draw less than 5A from a 28 VDC charging source measured with an electrolyte temperature between 27°C and 38°C. This characteristic applies to starting the second engine of a multi-engine vehicle, or the slave starting of another vehicle.

5.1.2.2 Initial engagement surges. During this disturbance, the voltage shall not fall below 6 VDC and the duration shall not exceed 1 second.

5.1.2.3 Cranking level. The steady voltage during cranking shall not fall below 16 VDC (no more than three cranking attempts of 30 seconds each with 2 minute cranking level pauses between attempts).

5.1.3 Normal operating mode. The vehicle system operates with the generator and batteries.

5.1.3.1 Steady-state voltage. The circuit steady-state voltage shall be between 25 VDC and 30 VDC.

5.1.3.2 Ripple. The upper and lower peaks of ripple voltage shall each be less than 2V from the steady state limits. The frequency components of the ripple shall be within the range 50 Hertz (Hz) to 200 kilohertz (kHz).

MIL-STD-1275D

5.1.3.3 Surges. All surges resulting from system operation shall fall within the envelope shown in Figure 5.

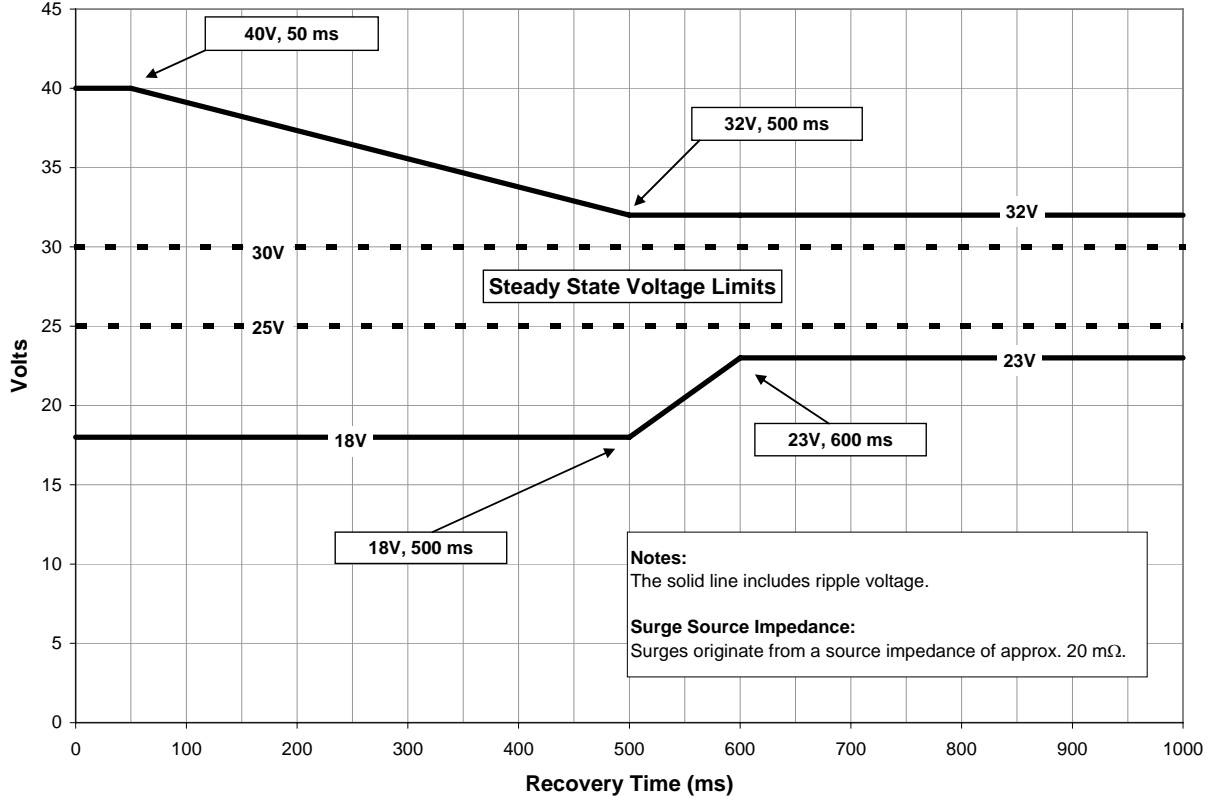

FIGURE 5. Envelope of Surges in Normal Operating Mode for 28 VDC Systems.

MIL-STD-1275D

5.1.3.4 Spikes. All spikes resulting from system operation shall fall within the envelope shown in Figure 6.

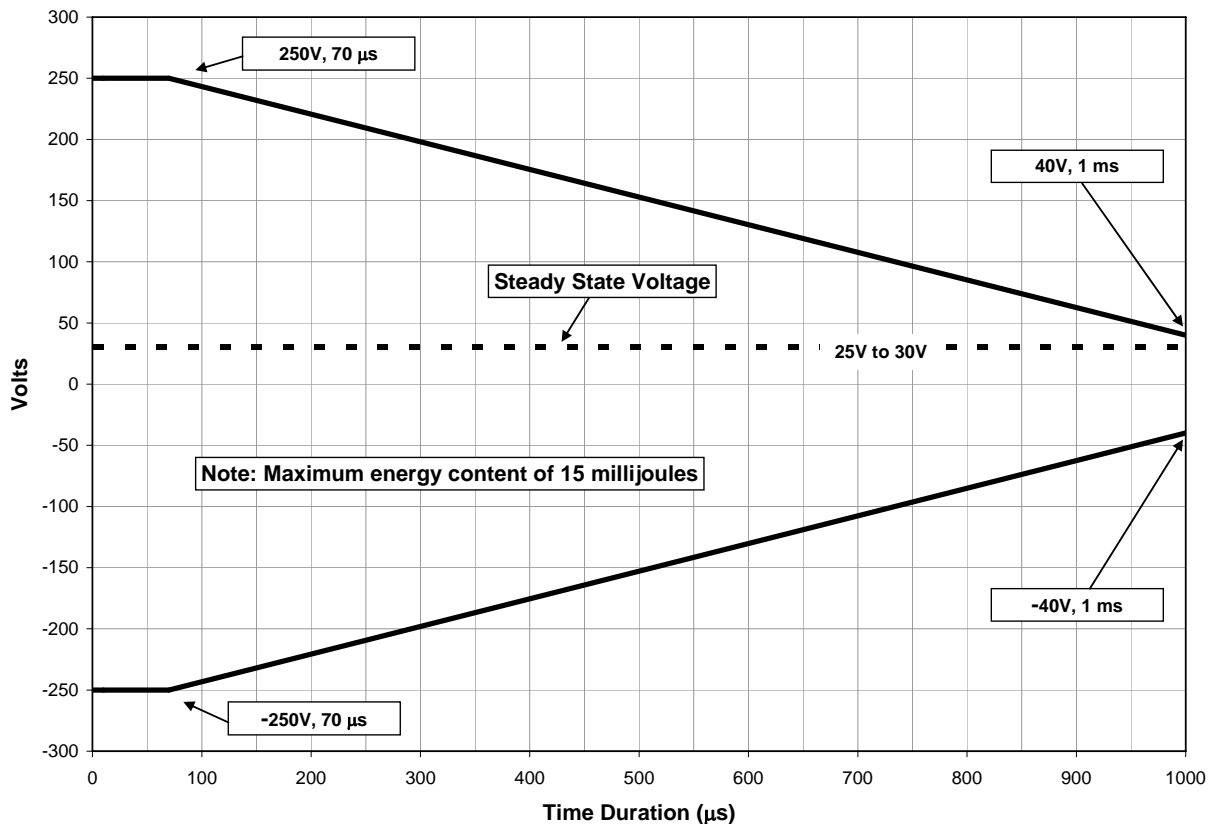

FIGURE 6. Envelope of Spikes in Normal Operating Mode for 28 VDC Systems.

5.1.4 Generator-only mode. The vehicle system operates with only the generator (i.e. no batteries).

5.1.4.1 Steady-state voltage. The circuit steady-state voltage shall be between 23 VDC and 33 VDC.

5.1.4.2 Ripple. The upper and lower peaks of ripple voltage shall each be less than 7V from the steady state limits. The frequency components of the ripple shall be within the range 50 Hz to 200 kHz.

MIL-STD-1275D

5.1.4.3 Surges. All surges resulting from system operation shall fall within the envelope shown in Figure 7.

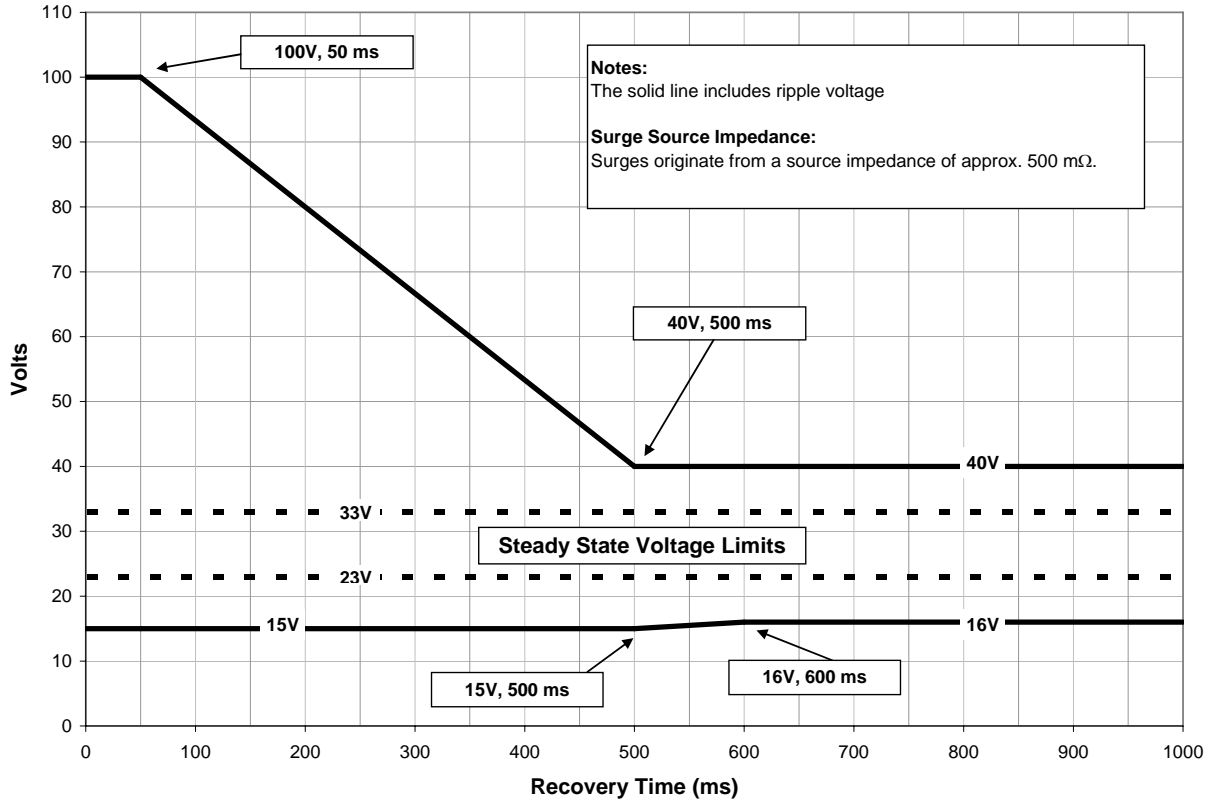

FIGURE 7. Envelope of Surges in Generator-only Mode for 28 VDC Systems.

5.1.4.4 Spikes. All spikes resulting from system operation shall fall within the envelope shown in Figure 8.

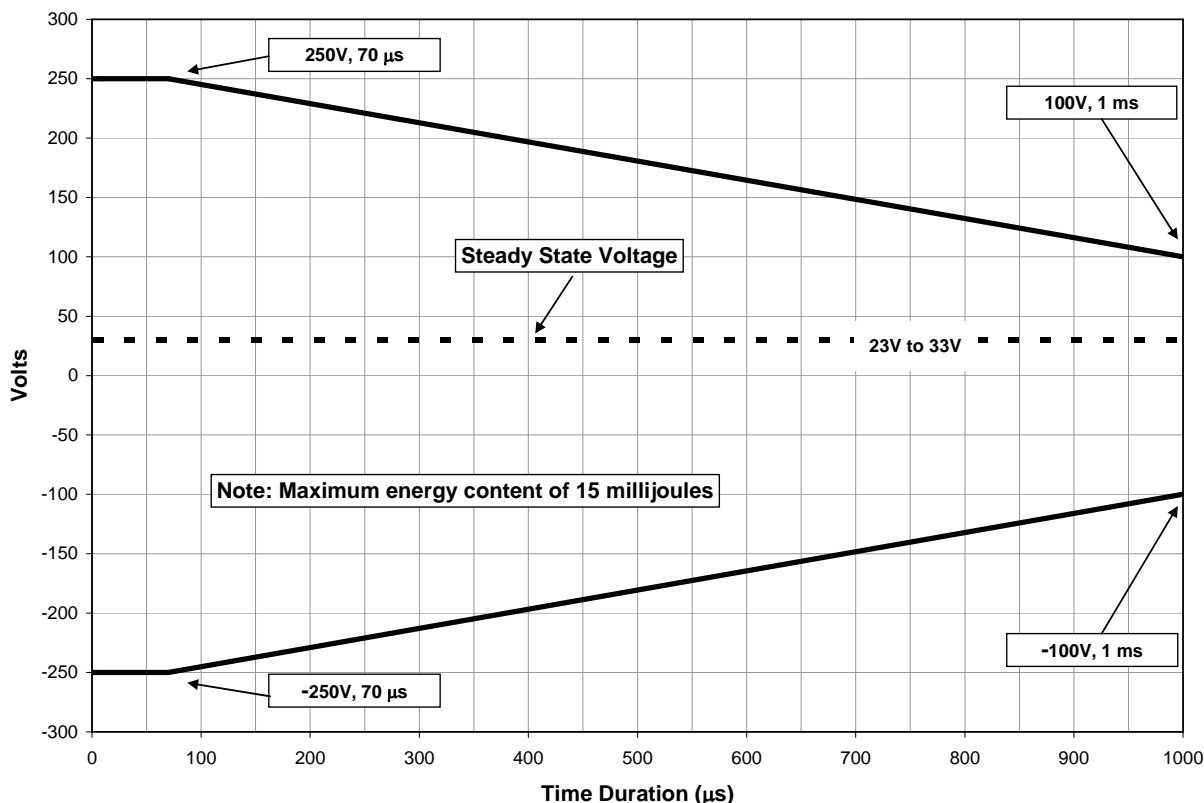

FIGURE 8. Envelope of Spikes in Generator-only Mode for 28 VDC Systems.

5.2 Compatibility of power supply system and utilization equipment. It is the responsibility of the appropriate authority to specify how the utilization equipment shall function during and after the disturbances cited in the detailed requirements. There shall be no influence from the utilization equipment that would cause the electrical system to depart from the limits specified in the detailed requirements.

5.3 Test methods. Care shall be taken to ensure that the electromagnetic environment or radiated background noise does not interfere with the measurement instrumentation setup.

MIL-STD-1275D

5.3.1 Vehicle electrical system. Measuring equipment and test procedures shall have the following minimum standards:

a. Ripple.

- (1) Measuring equipment. A digital oscilloscope (DO) capable of data acquisition and data sample storage shall meet the following requirements: input impedance of not less than 0.1 megaohm, bandwidth of DC to not less than 400 MHz, and a minimum input sensitivity of 5 mV/div.
- (2) Test procedure. Operate vehicle in normal operating and generator-only modes when recording measurements of ripple voltages. Ripple voltages can be simulated and imported onto the power lead(s) of an EDUT; see test method 5.3.2.5.

b. Spikes.

- (1) Measuring equipment. (Same as for ripple measurement).
- (2) Test procedure. Same as the ripple test procedure but with the following additions: voltage spikes shall be produced by inductive load switching including, as a minimum, sounding the horn, operating the bilge pumps (if any), starting and stopping the engine and rotating the turret (if any). Measure exported spikes as referenced in test method 5.3.2.2. Voltage spikes can be simulated and imported onto the power lead(s) of an EDUT; see test method 5.3.2.3.

c. Surges.

- (1) Measuring equipment. (Same as for ripple measurement).
- (2) Test procedure. Same as the spike test procedure but with the following additions: voltage surges shall also be produced by load switching from 10 percent to 85 percent and 85 percent to 10 percent of system current rating. The generator and engine operating RPM shall be adjusted to match this requirement as needed. In small systems (i.e. less than 40A) where it is impossible to achieve a minimum of 10 percent load, the minimum load shall be used. Voltage surges can be simulated and imported onto the power lead(s) of an EDUT; see test method 5.3.2.4.

5.3.2 Vehicle equipment.

5.3.2.1 General. It is the responsibility of the appropriate authority to specify the following:

- a. Which of the following tests shall be applied to the EDUT to determine whether it is compatible with an electrical system whose characteristics are defined in this standard.
- b. How the EDUT shall function before, during, and after these tests.
- c. The electrical and environmental conditions under which these tests are carried out.

- d. Any additional testing of imported voltage transients using any or all of the pulses referenced in SAE J1113-11.

5.3.2.2 Voltage spikes exported from EDUT. Using the test circuit shown in Figure 9, the EDUT shall be operated over its specified range of functions. Any switching operation capable of producing spikes shall be repeated a sufficient number of times to give a reasonable probability that the maximum spike voltage is recorded (e.g. 20 operations). In addition, where the power supply to the EDUT is normally provided via an independent vehicle mounted switch, the test shall be repeated using this switch connected as shown in Figure 10. No EDUT exported voltage spike shall exceed the given envelopes of the normal operating and generator-only modes for the appropriate voltage system when measured. No spike or combination of spikes arising from a single event shall have an energy content exceeding 15 millijoules.

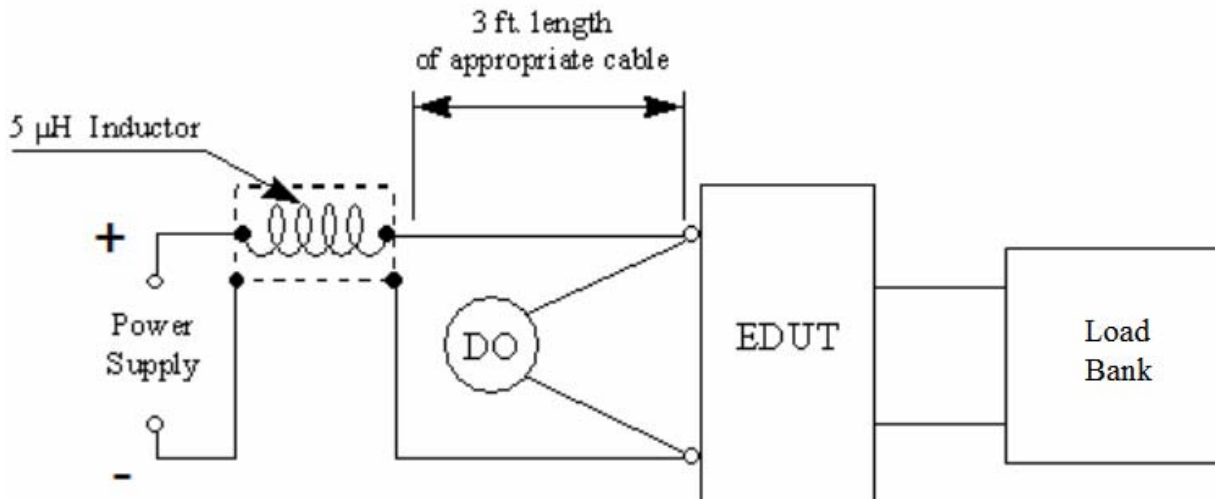

FIGURE 9. Exported Spike Test Circuit.

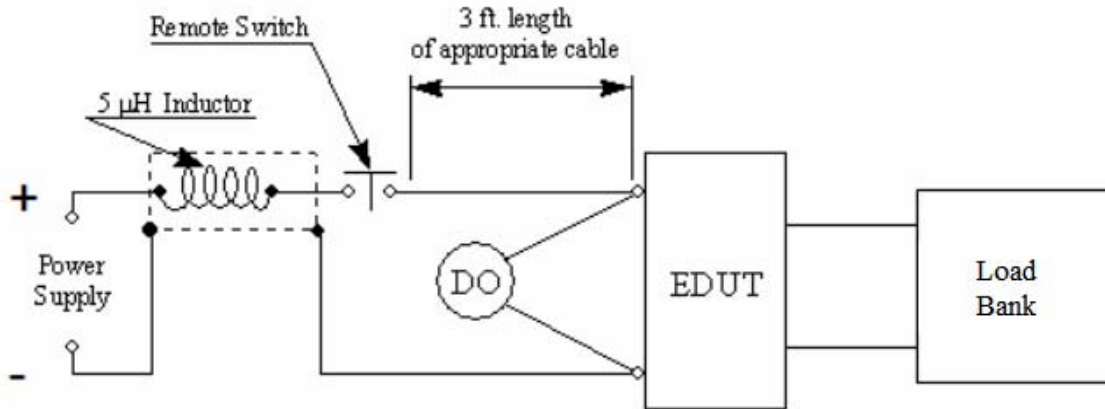

FIGURE 10. Exported Spike Test Circuit (EDUT With Remote Switch).

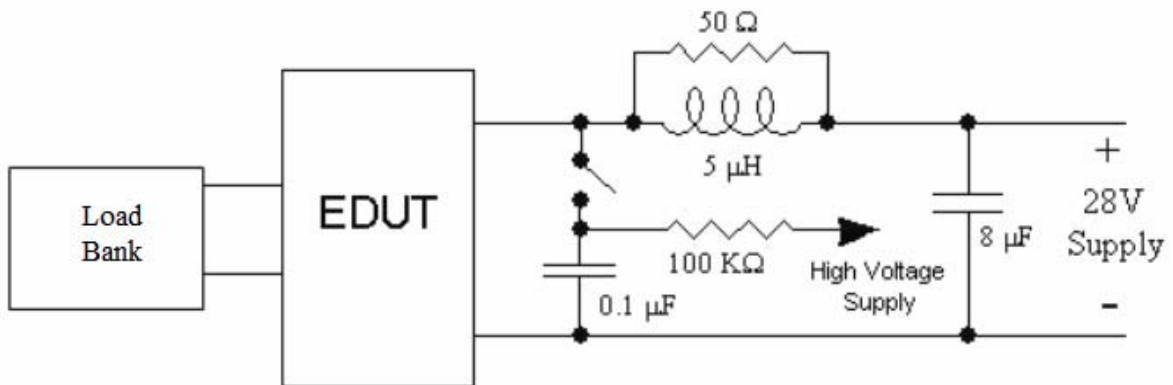

FIGURE 11. Imported Spike Test Circuit.

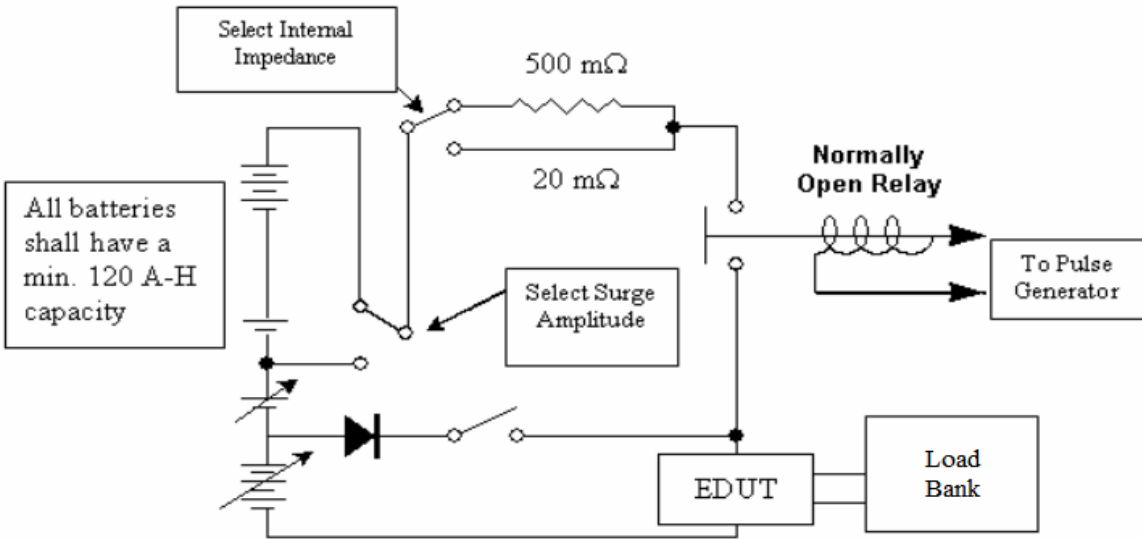

FIGURE 12. Imported Surge Test Circuit for 28 VDC Systems.

5.3.2.3 Voltage spikes imported into EDUT.

- a. An acceptable circuit is shown in Figure 11. The $5\ \mu\text{H}$ coil and $50\ \Omega$ resistor provides a stabilized source impedance with a frequency characteristic typical of that of a vehicle power supply circuit. The energy for the spike is stored in the $0.1\ \mu\text{F}$ capacitor charged from a high voltage DC source through a $100\ \text{k}\Omega$ resistor. When the switch is closed, a voltage step is produced, followed by a damped sinusoidal oscillation. The reset time of the voltage step is largely determined by the inductance of the series circuit of the capacitor and switch. To obtain the specified short risetime the inductance must be kept to a low value by the use of suitable components. A feed-through capacitor and a coaxial mounted high-speed relay together with short coaxial cables for the connecting leads are suggested. The peak amplitude of the spike is controlled by the DC charging voltage.
- b. For these tests, simulated voltage spikes shall be applied to the EDUT while it is operating at nominal voltage.
- c. Tests shall be carried out with both polarities of voltage spikes. The number of applications of spikes will depend upon the EDUT. A minimum of fifty 250V spikes of each polarity shall be applied at one (1) second intervals. Each test spike shall have a peak amplitude of 250V, a risetime not exceeding 50 ns, a frequency of oscillation greater than 100 kHz and less than 500 kHz, and a maximum energy content of 15 millijoules. The voltage spikes so imposed shall not damage the EDUT components nor affect the normal operation of the EDUT. Any deviation from normal operation, even an intermittent anomaly, such that it eventually returns to normal operation, shall be recognized as a failure of the EDUT.

5.3.2.4 Voltage surges imported into EDUT.

- a. For these tests, simulated voltage surge pulses in both the normal operating and generator-only modes shall be applied to the EDUT while it is operating within steady state conditions. The vehicle electrical system shall be represented in both the normal operating and generator-only modes. An acceptable circuit is shown in Figure 12.
- b. When simulating voltage surges in the normal operating mode, pulses of +40V total amplitude with 50 ms duration from a source impedance of 20 m Ω (i.e. representative of vehicle wire) shall be applied. The nominal supply voltage shall be maintained both before and after each pulse. The pulses shall be applied 5 times with a 1 second delay between pulses. The voltage surges so imposed shall not damage the EDUT components nor affect the normal operation of the EDUT. Any deviation from normal operation, even an intermittent anomaly, such that it eventually returns to normal operation, shall be recognized as a failure of the EDUT.
- c. After simulating voltage surges in the normal operating mode, pulses of +100V total amplitude with 50 ms duration from a source impedance of 500 m Ω (i.e. 50W or higher rated power resistor) shall be applied to simulate voltage surges in the generator-only mode. The nominal supply voltage shall be maintained both before and after each surge. The pulses shall be applied 5 times with a 1 second delay between pulses. The voltage surges so imposed shall not damage the EDUT components nor affect the normal operation of the EDUT. Any deviation from normal operation, even an intermittent anomaly, such that it eventually returns to normal operation, shall be recognized as a failure of the EDUT.
- d. The voltage surges specified in 5.3.2.4b and 5.3.2.4c shall have the amplitude established before connection of the EDUT. The power source shall be sensibly constant during the surge. The rise and fall times of the surge shall be approximately 1 ms. A minimum total of five +40V surges and five +100V surges shall be applied to the EDUT sample.

5.3.2.5 Ripple voltage imported into EDUT. Measuring equipment specified in 5.3.1 shall be used to monitor the ripple. Using the test methods of SAE J1113-2, simulated ripple voltage of a sinusoidal waveform shall be applied to the EDUT power lead(s) while it is operating over its specified range of functions in order to demonstrate indefinite immunity to ripple voltage over the frequency range of 50 Hz to 200 kHz. Verify the source impedance is \leq 0.5 ohms as described in Appendix A of SAE J1113-2. The upper and lower peaks of ripple voltage shall each be 7V from the generator-only steady state voltage limits. The EDUT shall be tested for a minimum of 1 minute at each ripple voltage frequency: 50Hz, 12kHz, 48kHz, and 200kHz. The ripple voltage so imposed shall not damage the EDUT components nor affect the normal operation of the EDUT. Any deviation from normal operation, even an intermittent anomaly, such that it eventually returns to normal operation, shall be recognized as a failure of the EDUT.

6. NOTES

(This section contains information of a general or explanatory nature, which may be helpful, but is not mandatory.)

6.1 Intended use. The purpose of this document is to provide for compatibility between vehicular electric power supply and utilization equipment by confining electric power characteristics within definitive limits and restricting the requirements imposed on the electric power by the utilization equipment.

6.2 Subject term (key word) listing.

- Electromagnetic interference (EMI)
- Electrostatic discharge (ESD)
- Fall time
- Polarity
- Recovery time
- Ripple
- Rise time
- Spike
- Starting disturbance
- Surge
- Voltage characteristics

6.3 International interest. Certain provisions of this standard are the subject of international standardization agreement NATO STANAG 2601. When a change notice, revision, or cancellation of this standard is proposed which will modify the international agreement concerned, the preparing activity will take appropriate action through international standardization channels, including departmental standardization offices, to change the agreement or make other appropriate accommodations.

6.4 Changes from previous issue. The margins of this standard are marked with vertical lines to indicate where changes from the previous issue were made. This was done as a convenience only and the Government assumes no liability whatsoever for any inaccuracies in these notations. Bidders and contractors are cautioned to evaluate the requirements of this document based on the entire content irrespective of the marginal notations and relationship to the last previous issue.

MIL-STD-1275D

Custodian:
Army – AT

Preparing Activity:
Army - AT

Review Activities:
Army - CR, MI, TE
DLA - CC

(Project 2920-2006-001)

NOTE: The activities listed above were interested in this document as of the date of this document. Since organizations and responsibilities can change, you should verify the currency of the information above using the ASSIST Online, database at <http://assist.daps.dla.mil>.